



Refrigerator user manual

English

imagine the possibilities

Thank you for purchasing a Samsung product.
To receive a more complete service,
please register your product at
www.samsung.com/global/register

SAMSUNG

features of your new refrigerator

KEY FEATURES OF YOUR NEW REFRIGERATOR

Your Samsung Side-By-Side Refrigerator comes equipped with many space-saving, innovative storage and energy-efficient features.

- **HIDDEN HINGES & DOOR S/W**

Slick-covered hidden hinges & door s/w helps Neat & Stylish square frontal view.

- **CoolSelect Zone™ Drawer (Optional)**

With this state of the art feature, you can select Quick Cool, Thaw or Select buttons to quickly chill, thaw and cool items just in the CoolSelect drawer. Select Soft Freeze, Cool or 0 Zone to control the temperature of drawer.

- **EASY OPENNING (Optional)**

Doors can be opened easily and smoothly with this "Easy Handle" for the customer satisfaction.

- **BLACK CLEAR LED DISPLAY (Optional)**

With luxurious black window, you can look and feel neat & clear design.

- **SOFT TOUCH TYPE HOME BAR (Optional)**

With soft touch type Home Bar, just push and catch to open or close with latch and damping system.

- **EASILY MOVABLE TRAY (Optional)**

New concept tray to increase the movability with food simultaneously. Useful for storage of dessert and cake etc.



For easy future reference write the model and serial number down. You will find your model number on the left hand side wall of the refrigerator.

Model # _____

Serial # _____

safety information

SAFETY INFORMATION



- Before operating the appliance, please read this manual thoroughly and retain it for your reference.



- Because these following operating instructions cover various models, the characteristics of your refrigerator may differ slightly from those described in this manual.

CAUTION/WARNING SYMBOLS USED

	Indicates that a danger of death or serious injury exists.
	Indicates that a risk of personal injury or material damage exists.

OTHER SYMBOLS USED

	Represents something you must NOT do.
	Represents something you must NOT disassemble.
	Represents something you must NOT touch.
	Represents something you must follow.
	Indicates that you must disconnect the power plug from the socket.
	Represents a ground is needed to prevent electric shock.
	It is recommended that this symbol be handled by service man.

These warning signs are here to prevent injury to you and others.

Please follow them explicitly.

After reading this section, keep it in a safe place for future reference.

- This refrigerator must be properly installed and located in accordance with the manual before it is used.
- Use this appliance only for its intended purpose as described in this instruction manual.
- We strongly recommend that any servicing be performed by a qualified individual.
- R600a or R134a can be used as a refrigerant. Check the compressor label on the rear of the appliance and the rating label inside the fridge to see which refrigerant is used for the refrigerator.



- In case of R600a refrigerant, this gas is natural gas with high environmental compatibility that is, however, also combustible. When transporting and installing the appliance, care should be taken to ensure that no parts of the refrigerating circuit are damaged.
- Refrigerant squirting out of the pipes could ignite or cause an eye injury. If a leak is detected, avoid any naked flames or potential sources of ignition and air the room in which the appliance is standing for several minutes.

safety information



- In order to avoid the creation of a flammable gas-air mixture if a leak in the refrigerating circuit occurs, the size of the room in which the appliance may be sited depends on the amount of refrigerant used.
- Never start up an appliance showing any signs of damage. If in doubt, consult your dealer.
- The room must be 1m³ in size for every 8g of R600a refrigerant inside the appliance.
- The amount of refrigerant in your particular appliance is shown on the identification plate inside the appliance.
- Please dispose of the packaging material for this product in an environmentally friendly manner.
- Pull the power plug out of the socket before changing the interior light of the refrigerator.
 - Otherwise, there is a risk of electric shock.

SEVERE WARNING SIGNS



- Do not install the refrigerator in a damp place or place where it may come in contact with water.
 - Deteriorated insulation of electrical parts may cause an electric shock or fire.
- Do not place this refrigerator in direct sunlight or expose to the heat from stoves, room heaters or other appliance.
- Allow sufficient space to install the refrigerator on a flat surface.
 - If your refrigerator is not level, the internal cooling system may not work correctly.
- Do not plug several appliances into the same multiple power board. The refrigerator should always be plugged into its own individual electrical which has a voltage rating that matched the rating plate.
 - This provides the best performance and also prevents overloading house wiring circuits, which could cause a fire hazard from overheated wires.
- Never unplug your refrigerator by pulling on the power cord. Always grip plug firmly and pull straight out from the outlet.
 - Damage to the cord may cause a short-circuit, fire and/or electric shock.
- Make sure that the power plug is not squashed or damaged by the back of the refrigerator.
- Do not bend the power cord excessively or place heavy articles on it.
 - This constitutes a fire hazard.
- Have the power cord repaired or replaced immediately by the manufacturer or its service agent if power cord has become frayed or damaged.
- Do not use a cord that shows cracks or abrasion damage along its length or at either end.
- If the power cord is damaged, have it replaced immediately by the manufacturer or its service agent.
- When moving the refrigerator, be careful not to roll over or damage the power cord.
- Do not insert the power plug with wet hands.
- Unplug the refrigerator before cleaning and making repairs.
- Do not use a wet or damp cloth when cleaning the plug.
- Remove any foreign matter or dust from the power plug pins.
 - Otherwise there is a risk of fire.
- If the refrigerator is disconnected from the power supply, you should wait for at least ten minutes before plugging it back.
- If the wall socket is loose, do not insert the power plug.
 - There is a risk of electric shock or fire.
- The appliance must be positioned so that the plug is accessible after installation.



- The refrigerator must be grounded.
 - You must ground the refrigerator to prevent any power leakages or electric shocks caused by current leakage from the refrigerator.



- Never use gas pipes, telephone lines or other potential lightening rods as ground.
 - Improper use of the ground plug can result in electric shock.
- Do not disassemble or repair the refrigerator by yourself.
 - You run risk of causing a fire, malfunction and/or personal injury.
- If you smell pharmaceutical or smoke, pull out power plug immediately and contact your Samsung electronics service center.
- Keep ventilation opening in the appliance enclosure or mounting structure clear of obstruction.
- Do not use mechanical devices or any other means to accelerate the defrosting process, other than those recommended by the manufacturer.
- Do not damage the refrigerant circuit.
- Do not place or use electrical appliance inside the refrigerator/freezer, unless they are of a type recommended by the manufacturer.
- Before changing the interior light, unplug the appliance from the power supply.
- If you experience difficulty when changing the light, contact your service center.
- The appliance is not intended for use by children or infirm persons without supervision.
- Children should be supervised to ensure that they do not play with the appliance.
- Do not let children hang on the door. If not, a serious injury may occur.
- Do not touch the inside walls of the freezer or products stored in the freezer with wet hands.
 - This may cause frostbite.
- If the refrigerator is not to be used for a long period of time, pull out the power plug.
 - Deterioration in the insulation may cause fire.
- Do not store articles on the top of the appliance.
 - When you open or close the door, the articles may fall and cause personal injury and/or material damage.

CAUTION SIGNS



CAUTION

- This product is intended only for the storage of food in a domestic environment.
- Manufacturer's recommended storage times should be adhered to.
 - Refer to relevant instructions
- Bottle should be stored tightly together so that they do not fall out.
- Do not place carbonated or fizzy drinks in the freezer compartment
- Do not overfill the refrigerator with food.
 - When you open the door, an item may fall out and cause personal injury or material damage.
- Do not put bottles or glass containers in the freezer.
 - When the contents freeze, the glass may break and cause personal injury.
- Do not spray inflammable gas near the refrigerator.
 - There is a risk of explosion or fire.
- Do not directly spray water inside or outside the refrigerator.
 - There is a risk of fire or electric shock.
- Do not store volatile or flammable substances in the refrigerator.
 - The storage of benzene, thinner, alcohol, ether, LP gas and other such products may cause explosions.
- If you have a long vacation planned, you must empty the refrigerator and turn it off.
- Do not re-freeze frozen foods that have thawed completely.
- Do not store pharmaceuticals products, scientific materials or temperature-sensitive products in the refrigerator.
 - Products that require strict temperature controls must not be stored in the refrigerator.
- Do not put a container filled with water on the refrigerator.
 - If spilled, there is a risk of fire or electric shock.

safety information

CAUTION SIGNS FOR CLEANING

- Do not insert your hands into the bottom area under the appliance.
 - Any sharp edges may cause personal injury.
- Never put fingers or other objects into the dispenser hole and ice chute.
 - It may cause personal injury or material damage.
- Do not use a wet or damp cloth when cleaning the plug, remove any foreign material or dust from the power plug pins.
 - Otherwise there is a risk of fire.
- If the refrigerator is disconnected from the power supply, you should wait for at least five minutes before plugging it back.

WARNING SIGNS FOR DISPOSAL

- When disposing of this or other refrigerator/s, remove the door/door seals, door latch so that small children or animals cannot become trapped inside.
- Leave the shelves in place so that children may not easily climb inside.
- R600a or R134a is used as a refrigerant. Check the compressor label on the rear of the appliance or the rating label inside the fridge to see which refrigerant is used for your refrigerator. When this product contains flammable gas(Refrigerant R600a) contact your local authority in regard to safe disposal of this product.
- Cyclopentane is used as a insulation blowing gas. The gases in insulation material require special disposal procedure. Please contact your local authorities in regard to the environmentally safe disposal of this product. Ensure that none of the pipes on the back of the appliances are damaged prior to disposal. The pipes shall be broke in the open space.



In the event of a power failure, call the local office of your Electricity Company and ask how long it is going to last.

Most power failures that are corrected in an hour or two will not affect your refrigerator temperatures.

However, you should minimize the number of door openings while the power is off.

But should the power failure last more than 24hours, remove all frozen food.

For doors or lids fitted with locks and keys, the keys be kept out of the reach of children and not in the vicinity of the refrigerating appliance, in order to prevent children from being locked inside.

safety information

ADDITIONAL TIPS FOR PROPER USAGE



- Allow the appliance to stand for 2hours after installation.
- To get best performance of product,
 - Do not place foods too closely in front of the vents at the rear of the appliance as it can obstruct free air circulation in the freezer compartment.
 - Wrap the food up properly or place it in airtight containers before put it into the fridge freezer
 - Do not put any newly introduced food for freezing near to already frozen food.
- Do not place carbonated or fizzy drinks in the freezer compartment
- Please observe maximum storage times and expiry dates of frozen goods.
- There is no need to disconnect the refrigerator from the power supply if you will be away for less than three weeks. But, remove all the food if you are going away for the three weeks or more. Unplug the refrigerator and clean it, rinse and dry.
- Most power failures that are corrected in an hour or two will not affect your refrigerator temperatures. However, you should minimize the number of door openings while the power is off. But should the power failure last more than 24hours, remove all frozen food.
- If the key is provided with refrigerator, the keys should be kept out of the reach of children and not in the vicinity of the appliance.
- The appliance might not operate consistently (possibility of defrosting of contents or temperature becoming too warm in the frozen food compartment) when sited for an extended period of time below the cold end of the range of temperatures for which the refrigerating appliance is designed.
- Do not store food which goes bad easily at low temperature, such as bananas, melons.
- Place the ice tray at the originally provided position by manufacturer in order to achieve optimal ice-freezing.
- Your appliance is frost free, which means there is no need to manually defrost your appliance, as this will be carried out automatically.
- Temperature rising during the defrost can comply with ISO requirement. But If you want to prevent an undue rise in the temperature of the frozen food while defrosting the appliance, please wrap the frozen food in several layers of paper such as newspaper.
- Any increase in temperature of frozen food during defrosting can shorten its storage life.

contents

SETTING UP YOUR SIDE-BY-SIDE REFRIGERATOR

9

- 9 Getting ready to install the refrigerator
- 10 Removing the refrigerator doors
- 13 Reattaching the refrigerator doors
- 16 Leveling the refrigerator

SETTING UP YOUR SIDE-BY-SIDE REFRIGERATOR

17

- 17 Making minor adjustments to the doors
- 18 Checking the water dispenser line(optional)
- 19 Installing the water dispenser line

OPERATING THE SAMSUNG SIDE-BY-SIDE REFRIGERATOR

23

- 23 Setting up the refrigerator
- 24 Operating the refrigerator
- 25 Using the digital display
- 26 Controlling the temperature
- 27 Using the ice and cold water dispenser
- 28 Shelves and bins
- 29 Storing food
- 31 Using the CoolSelect Zone™ Drawer (Optional)
- 33 Removing the freezer accessories
- 34 Removing the refrigerator accessories
- 35 Cleaning the refrigerator
- 37 Changing the interior lights
- 38 Changing the water filter
- 39 Using the doors

TROUBLESHOOTING

40

setting up your side-by-side refrigerator

GETTING READY TO INSTALL THE REFRIGERATOR

Congratulations on the purchase of your Samsung Side-By-Side Refrigerator. We hope you will enjoy the many state-of-the-art features and efficiencies that this new appliance has to offer.

Selecting the best location for the refrigerator

- Select a location with easy access to the water supply.
- Select a location without direct exposure to sunlight.
- Select a location with level (or nearly level) flooring.
- Select a location with enough space for the refrigerator doors to open easily.
- Allow sufficient space to install the refrigerator on a flat surface.
 - If your refrigerator is not level, the internal cooling system may not work correctly.
 - Overall space required in use. Refer to drawing and dimension as below.

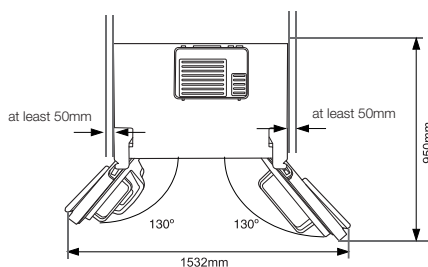
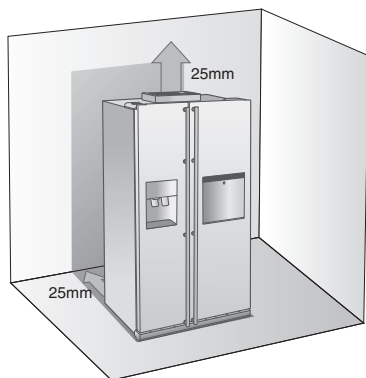

- Allow clearance to the right, left, back and top when installing. This will help reduce power consumption and keep your energy bills lower.
- Do not install the refrigerator where the temperature will go below 50°F (10°C).
- Make sure you disconnect the water supply line BEFORE removing the freezer door. See the next section on “Separating the Water Line” to avoid damage.

REMOVING THE REFRIGERATOR DOORS

If your entrance won't allow the refrigerator to pass easily through it, you can remove the doors.

1. Removing the Front Leg Cover

First, open both the freezer and refrigerator doors, and then take off the front leg cover by turning the three screws counter-clockwise.

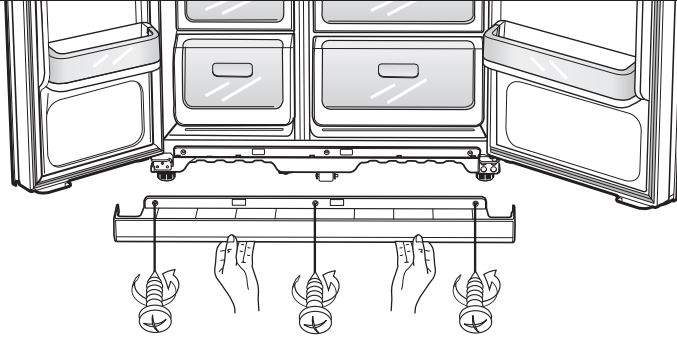

Separating the Water Supply Line from the Refrigerator

1. Remove the water line by pressing the coupler **1** and pulling the water line **2** away.

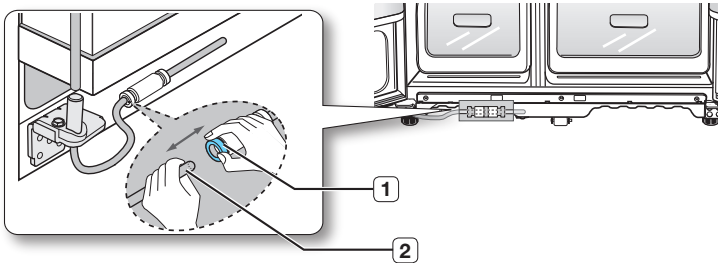

 Do not cut the water line. Gently separate it from the coupler.

setting up your side-by-side refrigerator

2. Removing the freezer door

A few things to mention first.

- Make sure that you lift the door straight up so the hinges are not bent or broken.
- Be careful not to pinch the water tubing and wire harness on the door.
- Place doors on a protected surface to prevent scratching or damage.

1. With the Freezer door closed, remove the upper hinge cover **1** using a screwdriver, and then disconnect the wires by gently pulling them apart **2**.

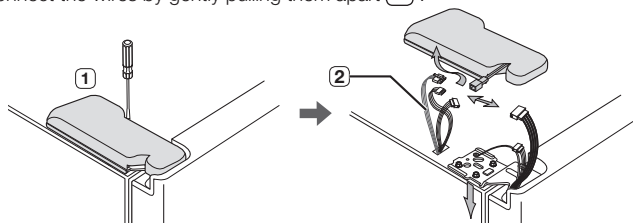

2. Remove hinge screws **3** and the ground screw **4** by turning counter-clockwise, and take off the upper hinge **5**. Be careful that the door does not fall on you as you are removing it

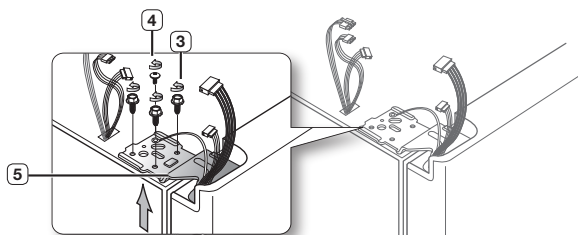

3. Next, remove the door from the lower hinge **6** by carefully lifting the door straight up **7**.

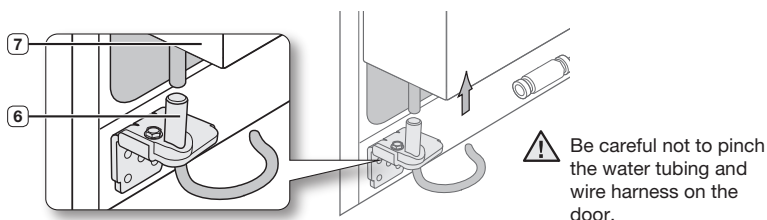

4. Remove the lower hinge **8** using a hex wrench.

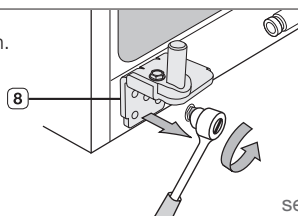

Removing the Fridge Door

1. With the door closed, remove the upper hinge cover **1** using a screwdriver.

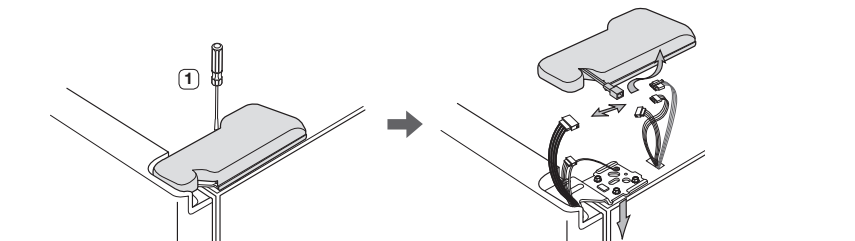

2. Remove hinge screws **2** and the ground screw **3** by turning counter-clockwise, and take off the upper hinge **4**. Be careful that the door does not fall on you as you are removing it

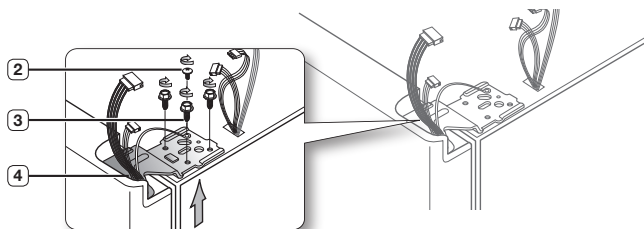

3. Remove the door from the lower hinge **5** by lifting the door straight up **6**.

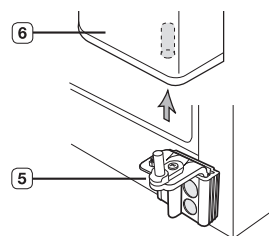

4. Remove the lower hinge **7** from the bracket **8** by gently lifting the lower hinge upwards.

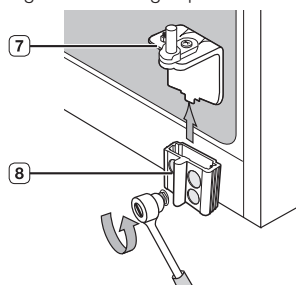

setting up your side-by-side refrigerator

REATTACHING THE REFRIGERATOR DOORS

Once you have safely placed your refrigerator where you plan for it to stay, it is time to put the doors back on.

Reattaching the Freezer Door

1. Replace the freezer door by inserting the water line **1** back into the lower corner of the door and then into the hole on the lower hinge **2**. Gently pull the water line back down so that it runs straight, with no kinks or bends.

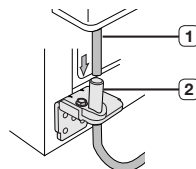

2. Insert the upper hinge shaft **3** into the hole on the corner of the freezer door **4**. Make sure the hinge is level between the upper hinge hole **5** and the hole of the cabinet **6** and reattach the hinge screws **7** and ground screw **8** by turning in a clockwise direction.

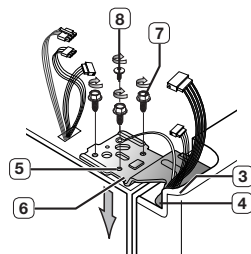

3. Reconnect the wires.

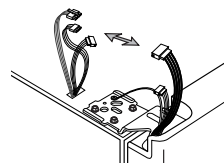

4. Place the front part of the upper hinge cover **9** on the front of the upper hinge **10** and reattach with the screw.

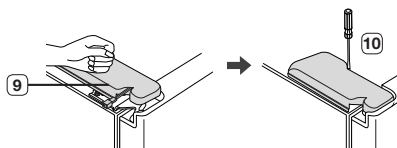

Reattaching the Fridge Door

1. Insert the lower hinge **1** back into the lower hinge bracket **2**.

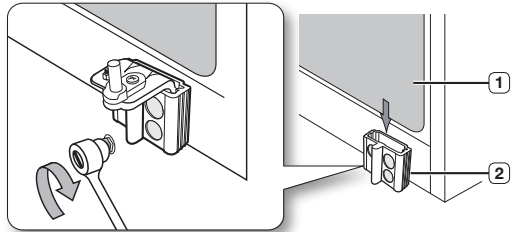

2. Fit the hole in the corner of the fridge door **3** over the lower hinge **4**.

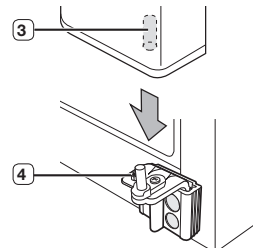

3. Insert the upper hinge shaft **5** into the hole on the hinge **6**. Make sure the hinge is level between the upper hinge hole **7** and the hole on the top of the cabinet **8**. Then, reattach hinge screws **9** and the ground screw **10** by turning it in a clock wise direction.

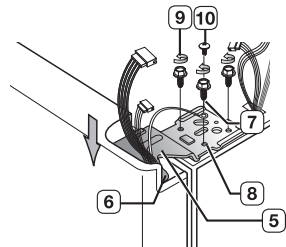

4. Place the front part of the upper hinge cover **11** on the front of the upper hinge **12** and reattach it with the screw.

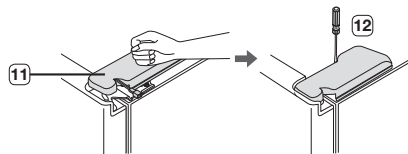

setting up your side-by-side refrigerator

Reattaching the Water Supply Line

1. Insert the water line **1** into the coupler **2**.

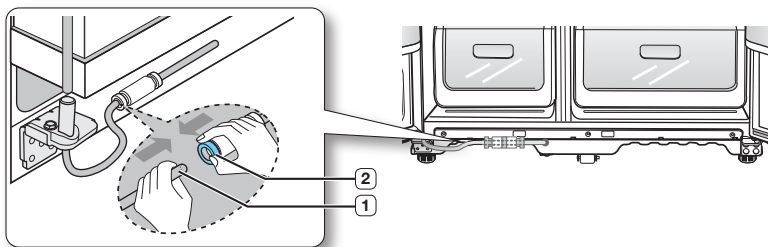

Reattaching the Front Leg Cover



Before attaching the cover, check water connector for leakage.

Replace the front leg cover by turning the three screws clockwise, as shown in the figure.

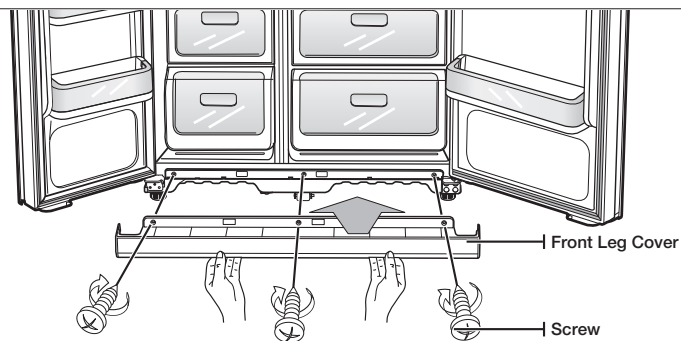

LEVELING THE REFRIGERATOR

Now that the doors are back on the refrigerator, you will want to make sure the refrigerator is level so you can then make final adjustments. If the refrigerator is not level, it will not be possible to get the doors perfectly even.

 The front of the refrigerator is also adjustable.

When the Freezer door is lower than the fridge

Insert a flat-blade screwdriver into a notch on the Leg, turn it clockwise or counter clockwise to level the freezer. turning the three screws counter-clockwise.

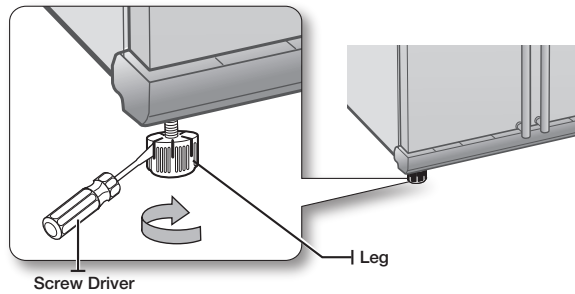

When the Freezer door is higher than the fridge

Insert a flat-blade screwdriver into a notch on the Leg, turn it clockwise or counter clockwise to level the fridge.

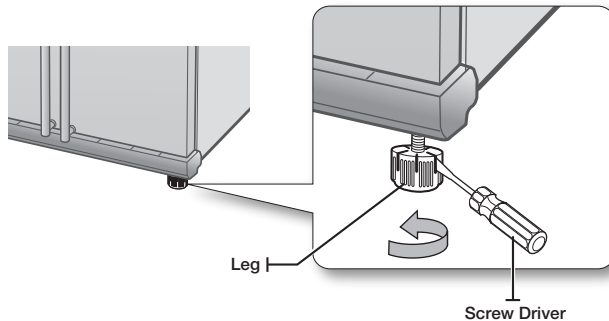

 Refer to the next section for the best way to make very minor adjustments to the doors.

setting up your side-by-side refrigerator

MAKING MINOR ADJUSTMENTS TO THE DOORS

Remember, a leveling refrigerator is necessary for getting the doors perfectly even. If you need help, review the previous section on leveling the refrigerator.

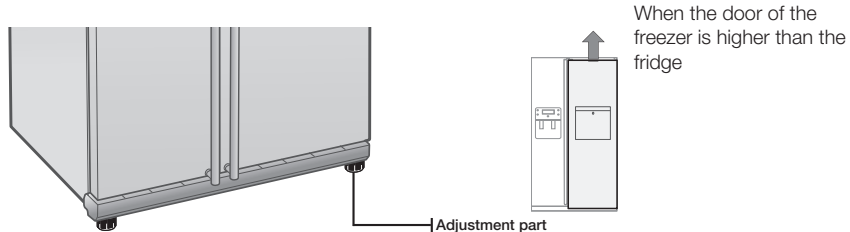

In the case of the process to correct the imbalance is the same. Open the doors and adjust them, one at a time, as follows:

1. Unscrew the nut **1** from the lower hinge until it reaches the upper end of the bolt **2**.

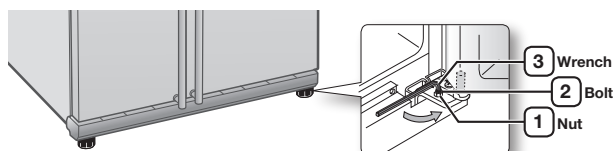

- When you release the nut **1**, make sure that you use the Allen wrench provided **3** to loosen the bolt **2** in a counter-clockwise direction. You should then be able to unscrew the nut **1** with your fingers.

2. Adjust the height difference between the doors by turning the bolt **2** clockwise ↻ or counter clockwise ↻.

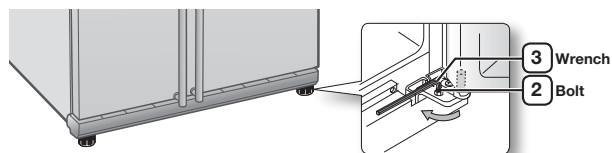

- When you turn clockwise ↻, the door will move up.

- After adjusting the doors, turn the nut **1** clockwise  until it reaches the lower end of the bolt, then tighten the bolt again with the wrench **3** to fix the nut in place **1**.

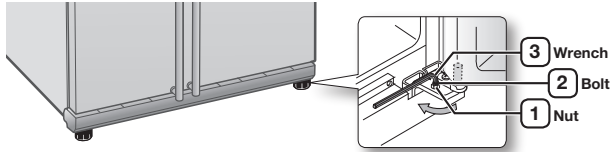

 If you do not secure the nut firmly, the bolt may release.

CHECKING THE WATER DISPENSER LINE (OPTIONAL)

A water dispenser is just one of the helpful features on your new Samsung refrigerator. To help promote better health, the Samsung water filter removes unwanted particles from your water. However, it does not sterilize or destroy microorganisms. You will need to purchase a water purifying system to do that. In order for the icemaker to operate properly, water pressure of 138 ~862 Kpa is required. Under normal conditions, a 170 cc paper cup can be filled in 10 seconds. If the refrigerator is installed in an area with low water pressure (below 138 Kpa), you can install a booster pump to compensate for the low pressure. Make sure the water storage tank inside the refrigerator is properly filled. To do this, press the water dispenser lever until the water runs from the water outlet.

 Water Line installation Kits are included with unit. You can find it in freezer drawer.

INSTALLING THE WATER DISPENSER LINE

For Interior model

Parts for water line Installation

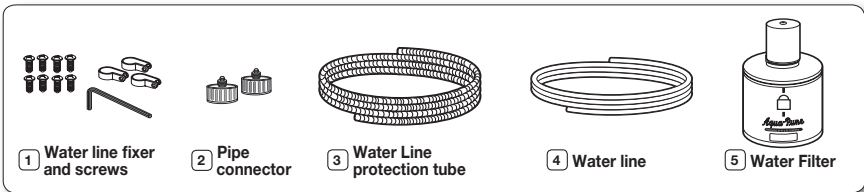

Connecting to the water supply line

- first, shut off the main water supply line.
- locate the nearest cold, drinking water line.
- follow the Water line Installation Instructions in the installation kit.

CAUTION

The water line must be connected to the cold water pipe. If it is connected to the hot water pipe, it may cause the purifier to malfunction.

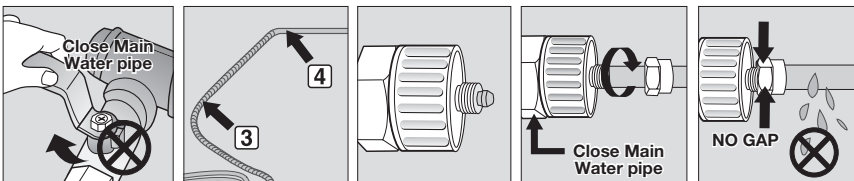

- After connecting the water supply to the water filter, turn your main water supply back on and dispense about 1l to clear and prime the water filter.

setting up your side-by-side refrigerator

Connecting the water line to the refrigerator

1. Remove the cap from water line on the unit and insert compression nut to the water line on the unit after disassembling from provided water line.
2. Connect both water line from the unit and water line provided kit.
3. Tighten the compression nut onto the compression fitting. Be careful no gap between two items.
4. Turn water on and check for any leakage.

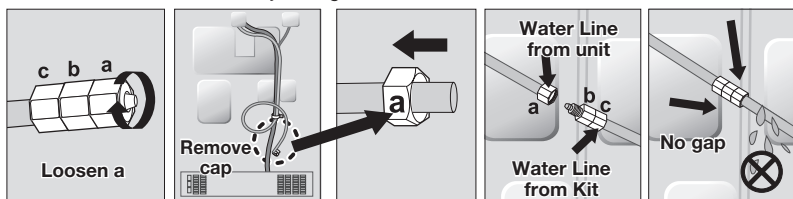

- Only connect the water line to a drinkable water source.
If you have to repair or disassemble the water line, cut off 6.5mm of the plastic tubing to make sure you get a snug, leak-free connection.

CAUTION Before being used, the leakage in these places should be examined

- Samsung Warranty does not cover WATER LINE INSTALLATION.
- It'll be done at customer's charge except the retail price includes installation cost.
- Please contact Plumber or Authorized Installer for the installation if needed.
- If Water leakage happened due to improper installation, Please contact installer.

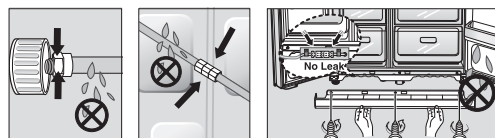

Installing the water filter.

1. Remove the water filter from the box and put a replacement indicator sticker on the filter as shown.
2. Place a sticker on the filter that dates six months in the future. For example, if you install the water filter in March, put the "SEP" sticker on the filter to remind you to replace in September. That way you'll know when it is time to replace the filter. Normally filter life is about 6 months.
3. Next, remove the fixed cap by turning it counter clockwise. Keep the cap in a safe place for use if you choose not to use a filter.
4. Remove the filter's protective cap and then position and insert the filter into the filter housing.
5. Slowly turn the water filter clockwise 90° to align with the indication mark on the cover, locking the filter in position. Make sure that the indicator is lined up with the "lock" position. Remember, do not over-tighten.

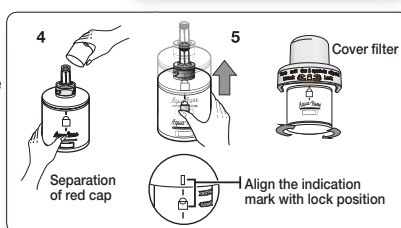
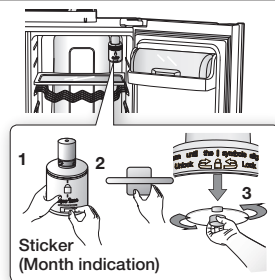

- If your model contains wine shelf, you should remove the wine shelf before installing water filters.

INSTALLING THE WATER DISPENSER LINE

For Exterior model

Parts for water line Installation

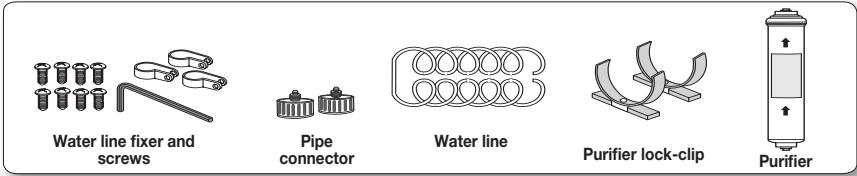

Connecting to the water supply line

Connect the water pipe with coupler and tap.

1. Close the main water tap.
2. Connect coupler "A" to the tap.

CAUTION

The water line must be connected to the cold water pipe. If it is connected to the hot water pipe, it may cause the purifier to malfunction.

WARRANTY INFORMATION

This water line installation is not covered by the refrigerator or ice maker manufacturer's warranty. Follow these instructions carefully to minimise the risk of expensive water damage.

Note:

If the coupler does not fit on the current tap, go the nearest authorised service dealer and purchase the right couplers fittings.

select the location where the purifier is to install. (Model with the purifier)

- If you wish to reassemble the water inlet and outlet sides of the purifier during purifier installation, see the reference illustration.
- Cut the water line attached to the purifier to the appropriate place after measuring the distance between the purifier and the cold water tap.

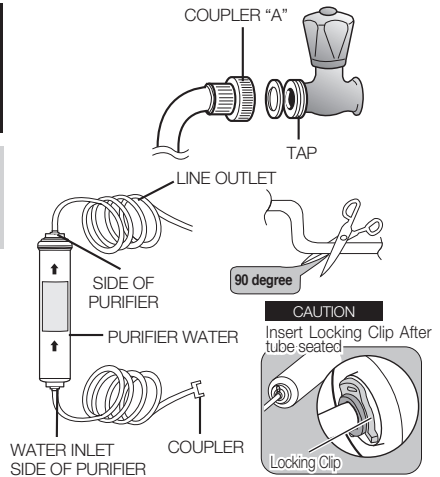

Replacement Instructions

1. Shut off water supply.
2. Note the Flow direction on the filter.
3. Insert water supply tube into the inlet side of the filter until the tube stop.

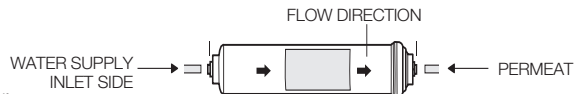

Note : You must also ensure that the cut is square and not at any sort of angle as this could cause a leak



4. After inserting tube, put together the clip strongly. The Clip fix the tube.

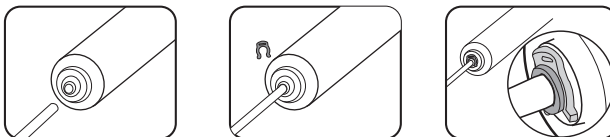

5. Turn on the water and check for leaks. If leaks occur, repeat step 1,2,3,4. If leaks persist, discontinue use and call your supporting dealer.
6. Flush filter for 5 minutes before use.

setting up your side-by-side refrigerator

Remove any residual matter inside the purifier. (Model with the purifier)

- Open the main water tap to check whether water is running through the water tube on the water inlet side of the purifier.
- If water does not come out through the line, check whether the tap is open.
- Leave the tap open until clean water is running out and any residual matter that built up during manufacturing has been removed.

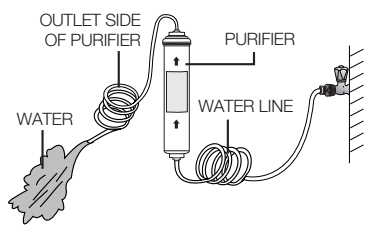

Attach the purifier lock-clip.

- Hold the purifier lock-clip in the appropriate position (under the sink for example) and fix it tightly into place where to screw.

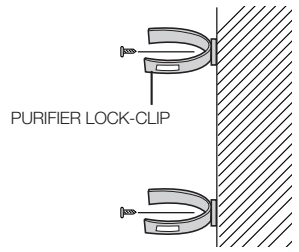

Secure the purifier in position.

- Fix the purifier in position, as shown in the figure on the right.

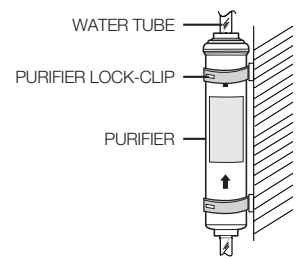

Connect the water line to the refrigerator.

- Remove the compressor cover of the refrigerator.
- Connect the water line to the valve, as shown in the figure.
- When connected, check if there is any leakage. If any, repeat the connection.
- Reattach the compressor cover of the refrigerator.

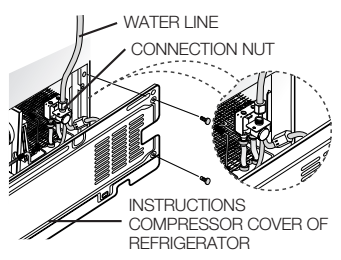

Secure the water line.

- Using clip "A", fix the water line to the wall (the back of refrigerator).
- When the water line is secure, make sure whether the water line is not excessively bent, pinched or squashed.

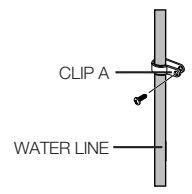

Removing any residual matter inside the water supply line after installing filter.

1. Turn ON the main water supply & turn OFF the valve to the water supply line.
2. Run water through the dispenser until the water runs clear (approx. 1L). This will clean the water supply system and remove air from the lines.
3. Additional flushing may be required in some households.
4. Open the refrigerator door and make sure there are no water leaks coming from the water filter.

-  A newly installed water filter cartridge may cause water to briefly spurt from the water dispenser. This is due to air getting into the line. It should pose no problem to operation.

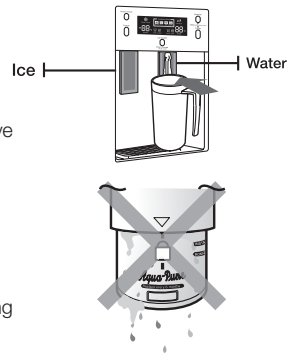

Check the amount of water supplied to the ice tray. (Optional)

1. Lift up the icemaker bucket and gently pull out of the freezer.
2. When you press the Test button for 3 seconds, the ice cube container is filled with water from the water supply tap after ice tray is twisted. Check to make sure the amount of water is correct(see the illustration below).

If the water level is too low, the ice cubes will be small. This is a water pressure problem from within the main water pipes, not the refrigerator.

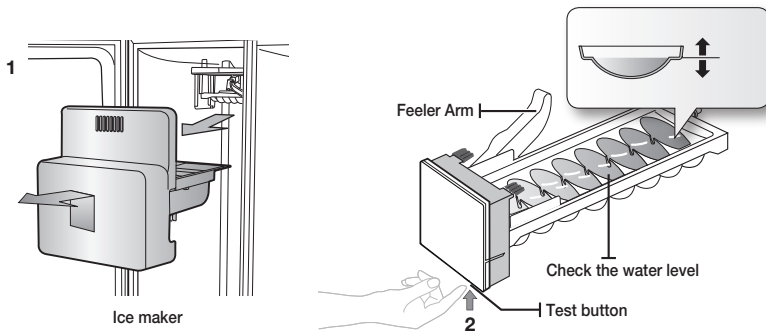

operating the SAMSUNG side-by-side refrigerator

SETTING UP THE REFRIGERATOR

Now that you have your new refrigerator installed and in place, you are ready to set up and enjoy the full features and functions of the appliance.

By completing the following steps, your refrigerator should be fully operational. If not, first check the power supply and electricity source or try the troubleshooting section at the back of this user guide. If you have any further questions, contact your Samsung Electronics service center.

1. Place the refrigerator in an appropriate location with reasonable clearance between the wall and the refrigerator. Refer to installation instructions in this manual.
2. Once the refrigerator is plugged in, make sure the interior light comes on when you open the doors.
3. Set the temperature control to the coldest temperature and wait for an hour.
The freezer should get slightly chilled and the motor should run smoothly.
4. After powering the refrigerator, it will take a few hours to reach the appropriate temperature. Once the refrigerator temperature is sufficiently cool, you can store food and drink in the refrigerator.

OPERATING THE REFRIGERATOR

USING THE CONTROL PANEL

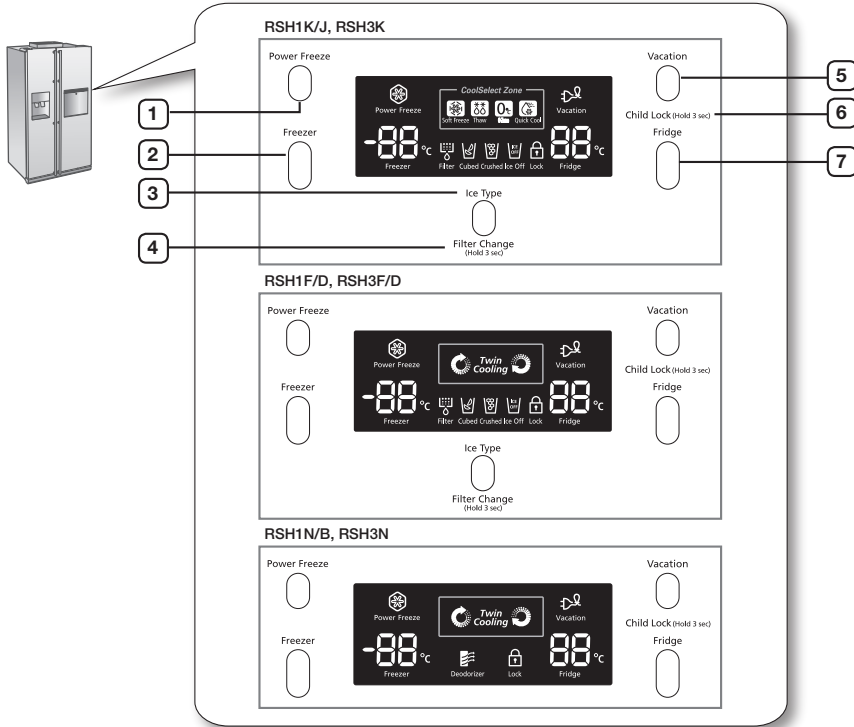

<p>1 POWER FREEZE BUTTON</p>	<p>Speeds up the time needed to freeze products in the freezer. This can be helpful if you need to quickly freeze items that spoil easily or if the temperature in the freezer has warmed dramatically (For example, if the door was left open).</p>
<p>2 FREEZER BUTTON</p>	<p>Press the Freezer button to set the freezer to your desired temperature, You can set the temperature between -14°C (8°F) and -25°C (-14°F).</p>
<p>3 ICE TYPE BUTTON</p>	<p>Use this button to choose Cubed, Crushed or to turn the Ice feature off.</p>
<p>4 FILTER CHANGE BUTTON</p>	<p>When you change the filter, press this button for 3 seconds to reset the filter schedule.</p>
<p>5 VACATION BUTTON</p>	<p>If you are going on vacation or business trip or you do not need to use the refrigerator, press the Vacation button. When you select vacation button for fridge compartment off, display LED of Vacation will be on. ! It is strongly requested to remove foods in the fresh-food compartment and do not leave the door open when you select Vacation function.</p>
<p>6 CHILD LOCK FUNCTION</p>	<p>By pressing the Vacation button and the Fridge button simultaneously for 3 seconds, all buttons will be locked. The Water dispenser lever and the Ice lever will not work either. To cancel this function, Press these two buttons for 3 seconds again.</p>
<p>7 FRIDGE BUTTON</p>	<p>Press the Fridge button to set the fridge to your desired temperature. You can set temperature between 1°C and 7°C (34°F and 45°F).</p>

operating the SAMSUNG side-by-side refrigerator

USING THE DIGITAL DISPLAY

“88” segment on Freezer part indicates the current Freezer temperature.

“88” segment on Fridge part indicates the current Fridge temperature.

“Quick Cool”, “thaw”, “soft freeze” and “0 Zone” indicates the status of the CoolSelect Zone™ Drawer.

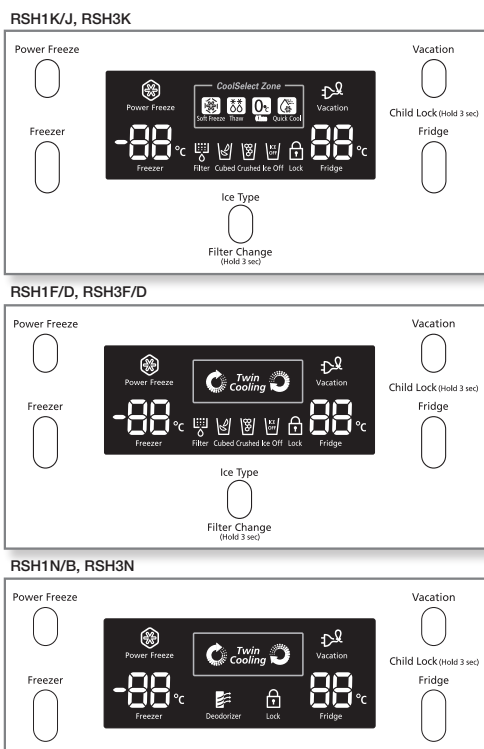

Power Freeze

This icon will light up when you activate the “Power freeze” feature. “Power freeze” is great for times when you need a lot of ice. Press the Power freeze button and ice production will increase. When you have enough, just press the button again to cancel the “Power freeze” mode.

 When you use this function the energy consumption of the refrigerator will increase. Remember to turn it off when you don't need it and return the freezer to your original temperature setting.

If you need to freeze large amount of food stuff, set the temperature of freezer compartment as the coldest temperature before you turn on the Power Freeze Button.

Filter Indicator

When the filter indicator light is on, it is time to change the filter. Typically this happens about every 6 months.

After removing the old water filter and installing a new one (see page 38 for instructions on how to do this), reset the indicator status light by pressing the **Ice Type** button for about 3 seconds.

The indicator will light again in about 6 months to let you know it is time to change your water filter. When you do not use the water filter, press the Ice Type button for more than 5 seconds, the Filter indicator lamp and the Filter Change letters will be off.

Child Lock

This icon will light up when you activate the Child Lock function by pressing the Vacation button and the Fridge button simultaneously for 3 seconds. Press these two buttons for 3 seconds again to reactivate.

Also, this button has another function. When this button is pressed for 3 seconds (lock indication lamp turn on), the heater for sweat control is off at a same time. If sweat is appeared around the cover dispenser or beverage station with this function, press this button for 3 seconds again. then, the light will turn off and the sweat control function will be performed. and all keys will be unlocked at a same time.

Cubed Ice, Crushed Ice and turning the Ice maker off.

Enjoy cubed or crushed ice by selecting your preference from the digital control panel. If you don't need ice, turn the feature off to save on water and energy consumption. The Ice type light indicates the type of ice(or no ice) that is currently chosen.



CONTROLLING THE TEMPERATURE

CONTROLLING THE FREEZER TEMPERATURE

The freezer temperature can be set between -14°C (8°F) and -25°C (-14°F) to suit your particular needs. Press the **Freezer** button repeatedly until the desired temperature is shown in the temperature display. Keep in mind that foods like ice cream may melt at -16°C (4°F).

The temperature display will move sequentially from -14°C (8°F) and -25°C (-14°F). When the display reaches -14°C (8°F), it will begin again at -25°C (-14°F).

Five seconds after the new temperature is set the display will again show the actual current freezer temperature. However, this number will change as the Freezer adjusts to the new temperature.

CONTROLLING THE FRIDGE TEMPERATURE

The refrigerator temperature can be set between 7°C (46°F) and 1°C (34°F) to suit your particular needs. Press the **Fridge** button repeatedly until the desired temperature is shown in the temperature display. The temperature control process for the Fridge works just like the Freezer process. Press the **Fridge** button to set your desired temperature. After a few seconds, the Fridge will begin tracking towards the newly set temperature. This will be reflected in the digital display.

 The temperature of the freezer or the refrigerator may rise from opening the doors too frequently, or if a large amount of warm or hot food is placed in either side. This may cause the digital display to blink. Once the freezer and refrigerator return to their normal set temperatures the blinking will stop. If the blinking continues, you may need to "reset" the refrigerator. Try unplugging the appliance, wait about 10 minutes and then plug back in.

operating the SAMSUNG side-by-side refrigerator

USING THE ICE AND COLD WATER DISPENSER

Press the Ice Type button to select the type of ice you want

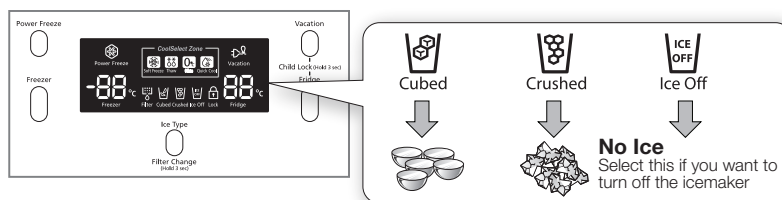

Ice is made in cubes. When you select "Crushed", the icemaker grinds the ice cubes into crushed ice.

Dispensing ice

Place your glass underneath the ice outlet and push gently against the ice dispenser lever with your glass. Make sure the glass is in line with the dispenser to prevent the ice from bouncing out.

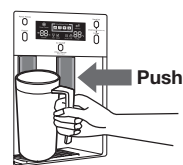

Using the Water Dispenser

Place a glass underneath the water outlet and push gently against the water dispenser lever with your glass. Make sure the glass is in line with the dispenser to prevent the water from splashing out.

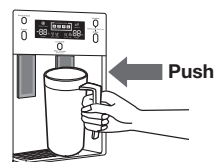

- Do not put your fingers, hands or any other unsuitable objects in the chute or ice-maker bucket.
 - It may result in personal injury or material damage.
- Never put finger or any other objects in the dispenser opening.
 - It may cause injury.
- Use only the ice maker provided with the refrigerator.
- The water supply to this refrigerator must only be installed/connected by a suitably qualified person and connect to a potable water supply only.
- In order to operate the ice maker properly, water pressure of 138 ~ 862 Kpa is required.



- If you have a long vacation or business trip and won't use water or ice dispensers, close the water valve.
 - Otherwise, water leakage may occur.
- Wipe excess moisture from the inside and leave the doors open.
 - Otherwise, odor and mold may develop.

SHELVES AND BINS

Freezer

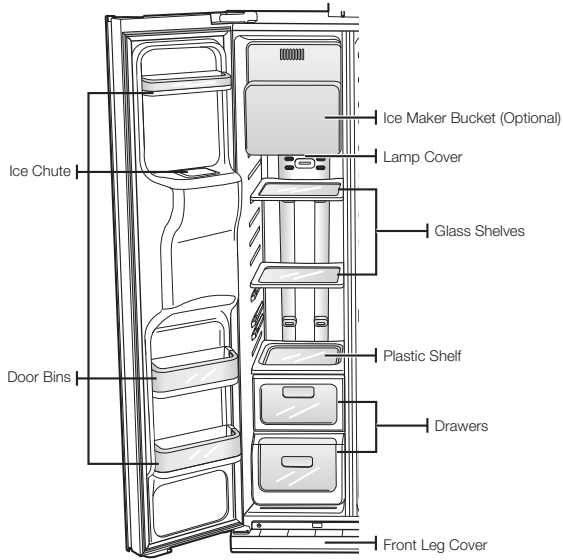

Fridge

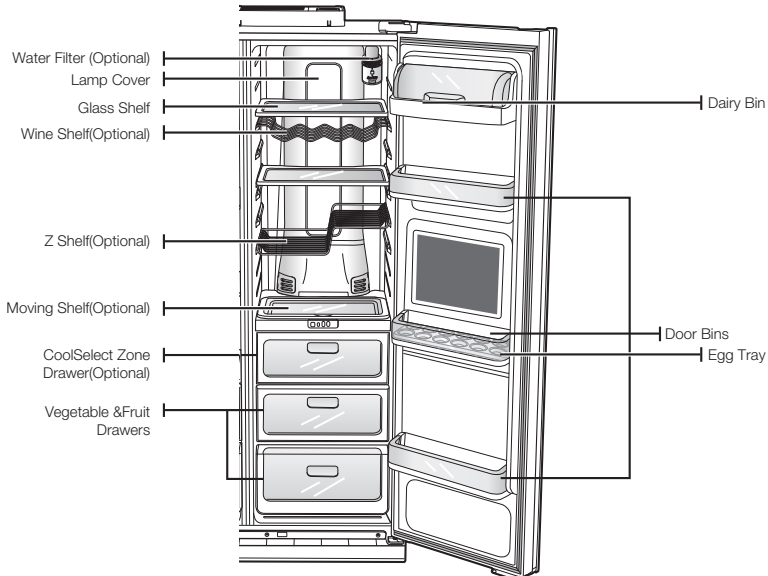



operating the SAMSUNG side-by-side refrigerator

STORING FOOD

Storing Food in the Freezer



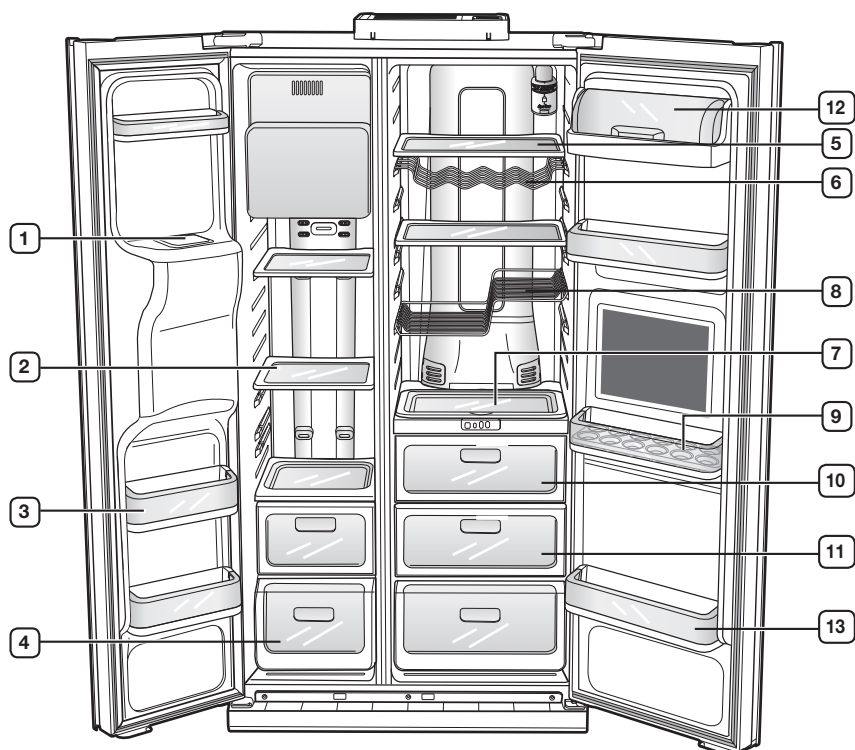

The Samsung Side-By-Side Refrigerator has been designed to provide you with maximum spacesaving features and functions. Here are some of the customized compartments we have created to keep your food fresher, longer. Remember, in order to prevent odor penetration to the ice, stored food should be wrapped securely and as airtight as possible.

 To get more space, you can remove top freezer drawers since it does not affect thermal and mechanical characteristics. A declared storage volume of frozen food storage compartment is calculated with these drawers removed.







 **CAUTION** In case the model has Cool Select Zone, do not insert a shelf to this rail, or the shelf can collide with beverage station cover and the beverage station cover can be broken.



Storing Food in the Freezer

1 ICE CHUTE 	Do not put your fingers, hands or any other objects in the ice chute or the ice maker bucket. This may result in personal injury or material damage.
2 SHELVES	Can be used to store all types of frozen food. 
3 DOOR BINS	Can be used for small packages of frozen food. 
4 DRAWERS	Best used to store meats or dry foods. Stored food should be wrapped securely using foil or other suitable wrapping materials or containers. 

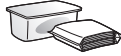
Storing Food in the Fridge

5 SHELVES	Designed to be crack-resistant. They can be used to store all types of food and drinks. Circular marks on the glass surface are a normal phenomenon and can usually be wiped clean with a damp cloth. 
6 WINE SHELF (OPTIONAL)	Helps wines maintain their taste by providing an optimized place for storing your wine bottles.
7 MOVING SHELF (OPTIONAL)	Designed to move with foods easily. It can be used to store all types food and drinks need to move often.
8 Z-SHELF (OPTIONAL)	Maximizing and efficiently space usage. Enough to store not wine bottles but also 2 liter carton of milk. 
9 EGG TRAY	Best place to keep eggs. Place the EGG TRAY on the shelf for easy access. 
10 COOLSELECT ZONE DRAWER (OPTIONAL)	Helps to preserve the taste, and prolong the freshness of your food. Use it to store cheese, meat, poultry, fish or any other foods that are consumed on a regular basis. 
11 FRUIT & VEGETABLE DRAWER	Used to preserve the freshness of your stored vegetables and fruits. It has been specifically designed to control the level of humidity within the drawer. 
12 DAIRY BIN	Can be used to store smaller dairy items like butter or margarine, yogurt or cream-cheese bricks. 
13 DOOR BINS	Designed to handle large, bulky items such as gallons of milk or other large bottles and containers. 

 Bottles should be stored tightly together so that they do not tip and fall out when the refrigerator door is opened.

WARNING

- If you plan to go away for a significant time, empty the refrigerator and turn it off. Wipe the excess moisture from the inside of the appliance and leave the doors open. This helps keep odor and mold from developing.
 - If the refrigerator is not to be used for a long period of time, pull out the power plug.
- Deterioration in the insulation may cause fire.

operating the SAMSUNG side-by-side refrigerator

USING THE COOLSELECT ZONE™ DRAWER (OPTIONAL)

The CoolSelect Zone™ Drawer is designed to make your busy life just a little bit easier.

Quick Cool Button

You can use the “Quick Cool” operation with the CoolSelect Zone™ Drawer to quickly cool 1–3 canned beverages in about an hour. When the “Quick Cool” process ends, the CoolSelect Zone™ Drawer automatically returns to the previously set temperature.

To cancel this operation, press the Quick Cool button again and the CoolSelect Zone™ Drawer returns to the previously set temperature.



Depending on the beverages, cool-down time may vary.



When “Quick Cool” is in operation, any items that you do NOT want affected should be moved out of the drawer.

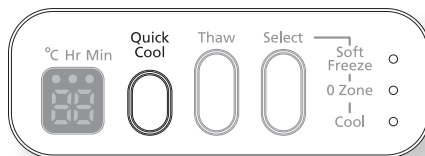

Thaw Button

When “thaw” is selected, warm and cold air is alternately blown into the CoolSelect Zone™ Drawer. Depending on the weight of the frozen food, you can select a 4 hrs, 6 hrs, 10 hrs, and 12 hrs thawing time.

When “thaw” ends, food is in a half-frozen state, making it easy to cut for cooking. In addition, when “thaw” ends, the CoolSelect Zone™ Drawer returns to the original “0 Zone” condition. To cancel this function mid-cycle, just press any button besides Thaw.

Here are the approximate thawing times of meat and fish by weight (and based on a 25.4mm (1in.) thickness). This chart represents the total weight of food in the CoolSelect Zone™ Drawer.

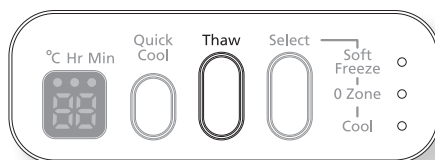

THAW TIME	4hours	6hours	10hours	12hours
WEIGHT	363g (0.8lb)	590g (1.3lb)	771g (1.7lb)	1000g (2.2lb)



Depending on the size and thickness of the meat or fish, thawing times may vary.



When “Thaw” is in operation, any items that you do NOT want affected should be moved out of the drawer.

Select Button

1. When “soft freeze” is selected on the CoolSelect Zone™ Drawer, the temperature on the drawer digital panel displays 23°F(-5°C), regardless of the overall temperature setting of the refrigerator. This feature helps keep meat and fish fresh for longer.
2. When “0 Zone” is selected, the temperature of the CoolSelect Zone™ Drawer is kept at 32°F(0°C), regardless of the overall temperature setting of the refrigerator. This feature also helps keep meat or fish fresh for longer.
3. When “Cool” is selected, the temperature in the CoolSelect Zone™ Drawer will be the same as the overall temperature setting of the refrigerator. The drawer digital panel shows the same temperature as that of the refrigerator display panel. Since the “Cool” function mimics the refrigerator temperature, you have extra general storage space.

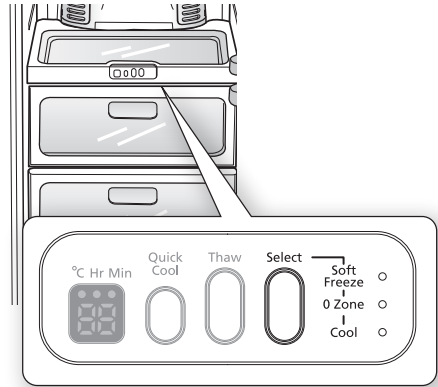

operating the SAMSUNG side-by-side refrigerator

REMOVING THE FREEZER ACCESSORIES

Cleaning and rearranging the interior of the freezer is a snap.

1. Remove the Glass shelf by pulling the shelf out as far as it will go. Then, gently lift it up and remove it.

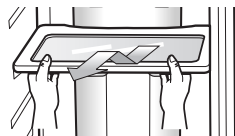

2. Remove the door bin by holding the door bin with both hands and then gently lift it up.

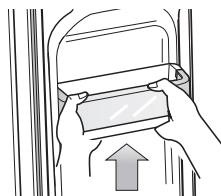

3. Remove the Plastic drawer by pulling it out and slightly lifting it up.

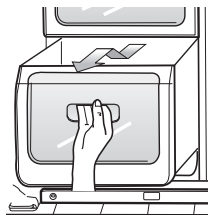

4. Remove the Icemaker bucket by lifting up and pulling it out.

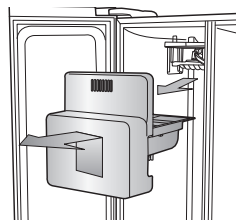

5. Remove the front leg Cover by opening both the freezer and refrigerator doors, and removing the three screws. Once the screws are free, detach the cover.
To reattach the front leg cover, place it back in its original position and tighten the three screws.

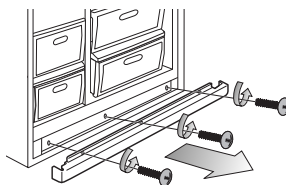

-  Do not use excessive force when removing the cover. Otherwise, the cover may break and cause injury.

REMOVING THE FRIDGE ACCESSORIES

1. Remove the **spill Proof Glass Shelf** by pulling the shelf out as far as it will go. Then, gently lift it up and gently remove it.

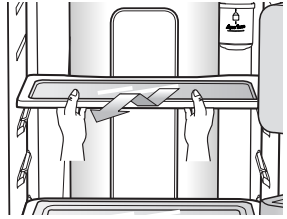

2. Remove the **Vegetable & Fruit Drawer** by pressing on the indentations found on the inside left and right sides of the Veggie Box/Dry Box cover and remove by pulling forward. Holding the drawer with one hand, lift it up a little bit while pulling it forward and take it out of the refrigerator.

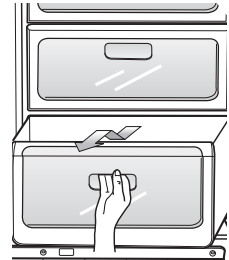

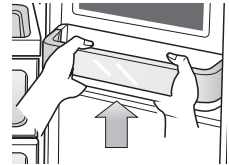

3. Remove the **Gallon Door Bin** by holding the bin with both hands and gently lifting it up.

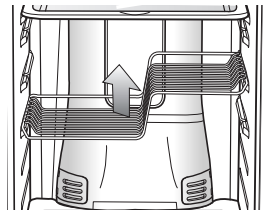

4. The **Z Shelf** is attached to the cabinet wall.
Remove the wine shelf by sliding it up and gently lifting the shelf out of the tabs.

 **CAUTION** Be careful not to assemble the Z shelf with being switched top and bottom, left and right.



-  Before removing any accessories, make sure that no food is in the way.
When possible, remove the food altogether to reduce the risk of accidents.

operating the SAMSUNG side-by-side refrigerator

CLEANING THE REFRIGERATOR

Caring for your Samsung Side-By-Side Refrigerator prolongs the life of your appliance and helps keep it odor and germ-free.

Cleaning the Interior

Clean the inside walls and accessories with a mild detergent and then wipe dry with a soft cloth. You can remove the drawers and shelves for a more thorough cleaning. Just make sure to dry them before putting them back into place.

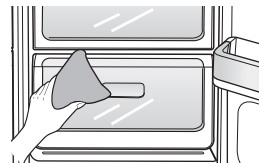

Cleaning the Exterior

Wipe the digital panel and display panel with a clean, soft cloth. Spray water onto the cleaning cloth instead of spraying directly on the surface of the refrigerator. This helps ensure an even distribution of moisture to the surface. The doors, handles and cabinet surfaces should be cleaned with a mild detergent and then wiped dry with a soft cloth. To keep your appliance looking its best, the exterior should be polished once or twice a year.

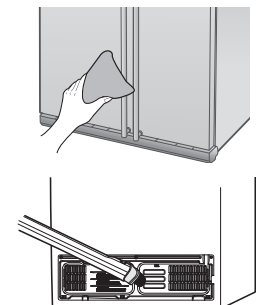

Do not use Benzene, Thinner or Clorox™ for cleaning.

WARNING They may damage the surface of the appliance and can create a risk of fire.

Cleaning the Soft touch type Home Bar

Use a damp cloth to clean the ice and water dispenser. Then wipe dry with a clean, soft cloth.



Use soft touch type Home Bar as follow

- In the case of opening the Home Bar, it will be opened automatically when you push the upper position of Home Bar until rattling.
- In the case of closing the Home Bar, push the upper position of Home Bar until rattling.

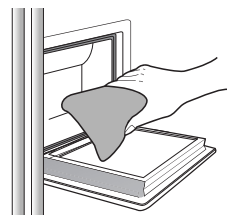

Cleaning the Rubber door seals

If the rubber door seals are dirty the doors may not close properly, and the refrigerator will not operate efficiently. Keep the door seals free of grit or grime by cleaning the doors with a mild detergent and damp cloth. Wipe dry with a clean, soft cloth.

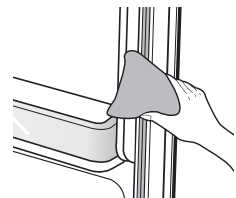

Do not spray the refrigerator with water while it is plugged in, as it may cause an electric shock.

WARNING Do not clean the refrigerator with benzene, thinner or car detergent for risk of fire.

Cleaning the Deodorizer (Optional)

To clean the twin deodorizer, remove the cover with a flat blade screwdriver. Remove the deodorizer cartridge from the cover and soak it in clean, warm water for at least 4 hours.

Then, allow the cartridge to dry completely before replacing it in the holder. This can take up to 8 hours in a well-ventilated area. For best results, repeat this process once or twice a year.

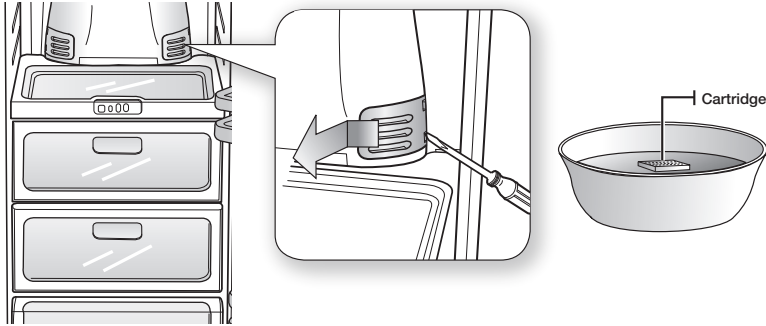

- ☑ If the cartridge dries in a confined (or humid) area, there may be an odor to the cartridge. If this occurs, re-clean and allow to dry in a well-ventilated area.

Cleaning behind the Refrigerator

To keep cords and exposed parts free of dust and dirt accumulation, vacuum behind the appliance once or twice a year.



WARNING

Do not remove the back cover. There can be a risk of electric shock.

operating the SAMSUNG side-by-side refrigerator

CHANGING THE INTERIOR LIGHTS

⚠ WARNING Pull the power plug out of the socket before changing the interior light of the refrigerator.
- Otherwise, there is a risk of electric shock. If you experience difficulty when changing the light, contact your service center.

Replacement bulbs for the fridge and freezer are available at most major retail outlets.
Use replacement bulb size E17 Maximum 30 Watts for the Fridge compartment and size E26 Maximum 40 Watts for the Freezer compartment.

✍ Changing the Interior Lights in the Refrigerator

UPPER LIGHT

✍ The number of bulb is differ from the model.

1. Push the lamp cover in on both sides to disengage the clips.
2. After changing the bulb, reattach the light cover.

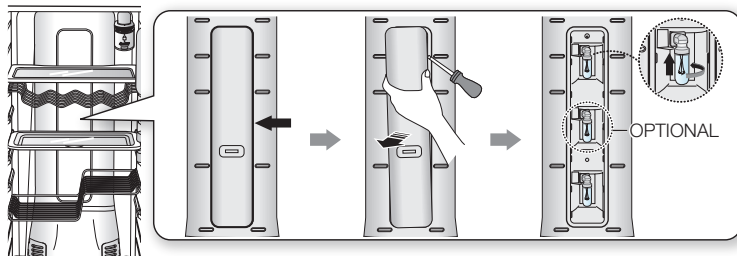

LOWER (OPTIONAL)

1. Remove the lamp cover by pulling out in the direction of the arrows.
2. After changing the bulb, reattach the light cover.

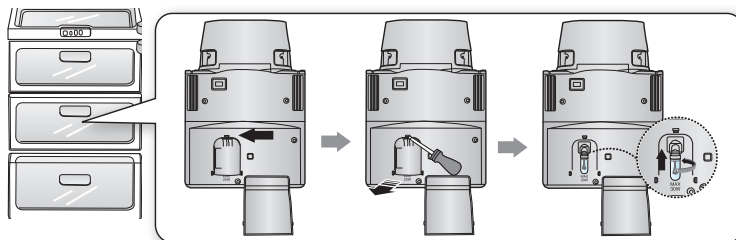

Changing the Interior Lights in the Freezer

The freezer light is located in the bottom of the auger motor case.

1. Lift the lamp cover up and pull out with 2 hands in the direction of arrows.
2. Replace the bulb with a new one.
3. Reattach the light cover.

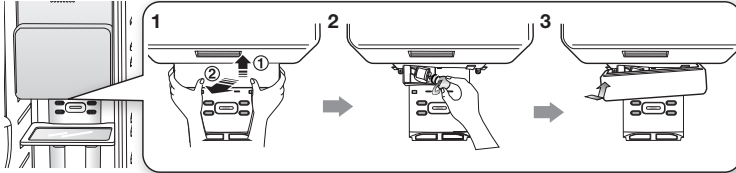

CHANGING THE WATER FILTER

The "Filter Indicator" light lets you know when it is time to change your water filter cartridge. To give you some time to get a new filter, the light will come on up just before the capacity of the current filter runs out. Changing the filter on time provides you with the freshest, cleanest water from your fridge.

-  1. Remove the water filter from the box and put a month indicator sticker on the filter as shown.
2. Place a sticker on the filter that dates six months in the future. For example, if you are replacing the water filter in March, put the "SEP" (September) sticker on the filter to remind you to replace in September. Normally filter life is about every 6 months.
3. Next, remove the fixed cap by turning it counter clockwise.
4. Remove the new filter's protective cap and remove the old filter.
5. Position and insert the new filter into the filter housing.

Slowly turn the water filter clockwise 90° to align with the indication mark on the cover, locking the filter in position. Make sure that the indicator is lined up with the "lock" position. Do not over tighten.

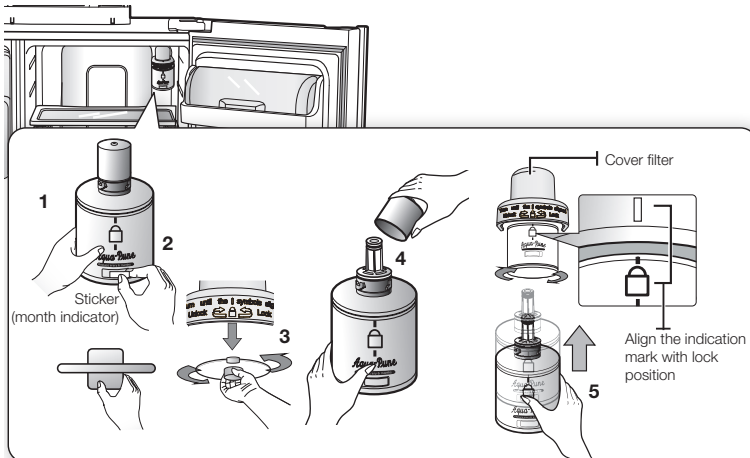

operating the SAMSUNG side-by-side refrigerator

6. Once you have completed this process, hold the **Ice Type** button for 3 seconds to reset the filter schedule.
7. Lastly, Dispense 1L of water through water dispenser and throw away. Make sure that water flows clearly again before drinking.

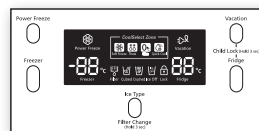

-  A newly installed water filter cartridge may cause water to briefly spurt from the water dispenser. This is due to air getting into the line. It should pose no problem to operation.

Ordering replacement filters

To order more water filter cartridges, contact your authorized Samsung dealer.

USING THE DOORS

The refrigerator doors are equipped with a door opening and closing feature that ensures that the doors close all the way and are securely sealed.

After opening beyond a certain point, the door will “catch” and remain open. When the door is ajar ahead of the catch that allows it to stay open, it will close automatically.

troubleshooting

PROBLEM	SOLUTION
The refrigerator does not work at all or it does not chill sufficiently.	<ul style="list-style-type: none"> • Check that the power plug is properly connected. • Is the temperature control on the display panel set to the correct temperature? Try setting it to a lower temperature. • Is the refrigerator in direct sunlight or located too near a heat source? • Is the back of the refrigerator too close to the wall and therefore keeping air from circulating?
The food in the fridge is frozen.	<ul style="list-style-type: none"> • Is the temperature control on the display panel set to the correct temperature? Try setting it to a warmer temperature. • Is the temperature in the room very low? • Did you store the food with a high water content in the coldest part of the fridge? Try moving those items into the body of the fridge instead of keeping them in the CoolSelect Zone™ drawer.
You hear unusual noises or sounds.	<ul style="list-style-type: none"> • Check that the refrigerator is level and stable. • Is the back of the refrigerator too close to the wall and therefore keeping air from circulating? • Was anything dropped behind or under the refrigerator? • A "ticking" sound is heard from inside the refrigerator. This is normal and occurs because various accessories are contracting or expanding in relation to the temperature of the refrigerator interior.
The front corners and sides of the appliance are hot and condensation is occurring.	<ul style="list-style-type: none"> • Some heat is normal as anti-condensators are installed in the front corners of the refrigerator to prevent condensation. • Is the refrigerator door ajar? Condensation can occur when you leave the door open for a long time.
Ice is not dispensing.	<ul style="list-style-type: none"> • Did you wait for 12 hours after installation of the water supply line before making ice? • Is the water line connected and the shut-off valve open? • Did you manually stop the ice making function? Make sure Ice Type is set to Cubed or Crushed. • Is there any ice blocked within the ice storage unit? • Is the freezer temperature too warm? Try setting the freezer temperature lower.
You can hear water bubbling in the refrigerator.	<ul style="list-style-type: none"> • This is normal. The bubbling comes from the refrigerant coolant liquid circulating through the refrigerator.
There is a bad smell in the refrigerator.	<ul style="list-style-type: none"> • Has a food item spoiled? • Make sure that strong smelling food (for example, fish) is wrapped so that it is airtight. • Clean out your freezer periodically and throw away any spoiled or suspect food.
Frost forms on the walls of the freezer.	<ul style="list-style-type: none"> • Is the air vent blocked? Remove any obstructions so air can circulate freely. • Allow sufficient space between the foods stored for efficient air circulation. • Is the freezer door closed properly?
Water dispenser is not functioning.	<ul style="list-style-type: none"> • Is the water line connected and the shut-off valve open? • Has the water supply line tubing been crushed or kinked? Make sure the tubing is free and clear of any obstruction. • Is the water tank frozen because the refrigerator temperature is too low? Try selecting a warmer setting on the main display panel.

English



Correct Disposal of This Product (Waste Electrical & Electronic Equipment) (Applicable in the European Union and other European countries with separate collection systems)

This marking shown on the product or its literature, indicates that it should not be disposed with other household wastes at the end of its working life. To prevent possible harm to the environment or human health from uncontrolled waste disposal, please separate this from other types of wastes and recycle it responsibly to promote the sustainable reuse of material resources.

Household users should contact either the retailer where they purchased this product, or their local government office, for details of where and how they can take this item for environmentally safe recycling.

Business users should contact their supplier and check the terms and conditions of the purchase contract. This product should not be mixed with other commercial wastes for disposal.

MEMO

MEMO



Contact SAMSUNG WORLD WIDE

If you have any questions or comments relating to Samsung products, please contact the SAMSUNG customer care center.

Country	Customer Care Center ☎	Web Site
AUSTRALIA	1300 362 603	www.samsung.com/au
CHILE	800-726-7864(SAMSUNG)	www.samsung.com/cl
CZECH REPUBLIC	844 000 844	www.samsung.com/cz
FRANCE	3260 SAMSUNG(7267864) or 08 25 08 65 65 (€ 0,15/min)	www.samsung.com/fr
GERMANY	01805 - 121213 (€ 0,14Min)	www.samsung.de
HONG KONG	3698 - 4698	www.samsung.com/hk
HUNGARY	06-80-SAMSUNG(7267864)	www.samsung.com/hu
INDONESIA	0800 112 8888	www.samsung.com/id
ITALIA	800-SAMSUNG(7267864)	www.samsung.com/it
MALAYSIA	1800-88-9999	www.samsung.com/my
MEXICO	01-800-SAMSUNG (7267864)	www.samsung.com/mx
NETHERLANDS	0900 20 200 88 (€0.10/Min)	www.samsung.com/nl
PHILIPPINES	1800-10-SAMSUNG (7267864)	www.samsung.com/ph
POLAND	0 801 801 881, 022-607-93-33	www.samsung.com/pl
RUSSIA	8-800-55-555-55	www.samsung.ru
SINGAPORE	1800-SAMSUNG (7267864)	www.samsung.com/sg
SLOVAKIA	0800-SAMSUNG(7267864)	www.samsung.com/sk
SOUTH AFRICA	0860 7267864 (SAMSUNG)	www.samsung.com/za
SPAIN	902 10 11 30	www.samsung.com/es
TAIWAN	0800-329-999	www.samsung.com/tw
THAILAND	1800-29-3232, 02-689-3232	www.samsung.com/th
TRINIDAD & TOBAGO	1-800-7267-864	www.samsung.com/latin
U.A.E	800SAMSUNG (7267864), 8000-4726	www.samsung.com/mea
U.K	0870 SAMSUNG (7267864)	www.samsung.com/uk
REPUBLIC OF IRELAND	0818 717 100	www.samsung.com/uk
U.S.A	1-800-SAMSUNG (7267864)	www.samsung.com/us
VENEZUELA	0-800-100-5303	www.samsung.com/latin
VIETNAM	1 800 588 889	www.samsung.com/vn
INDIA	3030 8282, 1800 110011	www.samsung.com/in